



Fireray® 5000

Motorised Reflective Auto-Aligning Beam Smoke Detector

The Fireray® 5000 motorised reflective, auto aligning infra-red beam smoke detector can be installed with up to two detector heads per system, thus saving on installation time and costs. In addition, each system controller houses two pairs of fire and fault relays, one per detector. This innovative system has been designed from the ground up to include pioneering technology that fully addresses the needs of the installer and user, both now and in the future.

With its industry leading optics, the Fireray® 5000 is ideally suited for the protection of large areas where the use of traditional detection technologies would prove to be too difficult and/or costly to install.

The Fireray® 5000 combines an infra-red transmitter and receiver in the same discrete unit and operates by projecting a well-defined beam to a reflective prism, which returns the beam to the receiver for analysis. Smoke in the beam path causes a drop in power, which, if below a pre-determined level, results in an alarm signal.

Features

- Allows for 2 detectors per system controller
- Each detector configurable from 8m to 100m
- Separate fire and fault relays per detector
- Integral LASER alignment
- Auto-Align fast automatic beam alignment
- Contamination compensation
- Low level system controller
- Logs the 50 most recent events per detector
- Programmable sensitivity and fire thresholds
- 20mm cable gland knock-outs on system controller
- 2-wire interface from system controller to detector
- Working optical path for detector alignment

Approvals:

World-wide approvals include:

FM

EN54:12

UL268

VdS

BOSEC

Visit www.ffeuk.com for up to date approvals information.



Operation

Getting the system operational is simplified by a number of ground breaking features that combine to make the Fireray® 5000 the quickest and easiest detector of its type to install. Each detector takes under 5 minutes to fully align.

A full range of installation accessories are available including the new Adjustment Bracket, which allows a greater degree of flexibility during installation.

Once the detector heads are connected, using the Easifit First-Fix system, an integral LASER can be activated. This allows the reflective prism to be positioned quickly and with confidence. Once the LASER has been used to coarsely align the beam, Auto-Align takes over and automatically steers the beam into the optimum position. During alignment the system automatically switches to high current mode and drops back to low current mode when in normal operation, however, alignment is still possible in low current mode.

Fireray® 5000 Accessories



Adjustment Bracket
PN: 5000-201

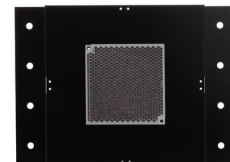

Reflector Wall Bracket
PN: 1031-000

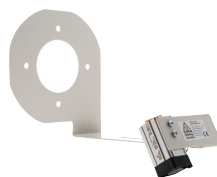

Anti-Condensation Heater
PN: 5000-204

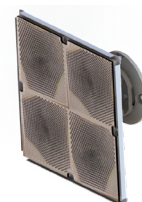

4 Reflector Adjustment Bracket
PN: 1050-000



Protective Wire Cage
PN: 1000-018

Fireray® 5000

Technical Specification

Parameter	Min.	Typ.	Max.	Unit
Operating Voltage (to System Controller)	14	-	36	VDC
Operating Current (constant) - with 1 detector	5	5.5	6	mA
Operating Current (constant) - with 2 detectors	7.5	8	8.5	mA
Operating Current (constant) - alignment modes, with 1 or 2 detectors	35	36	37	mA
Response Threshold/ Sensitivity (Default 35%)**	0.45	-	3.98	dB
	10	-	60	%
Delay to Alarm – user settable (Default 10 sec)	2	-	30	sec
Delay to Fault – user settable (Default 10 sec)	2	-	30	sec
Operating distance (separation)*	8	-	100	m
Maximum angular alignment of detector	-	-	±3.5	°C
Optical wavelength 850 nm				
Fault level/ Rapid obscuration ($\Delta \leq 2$ sec)	-	-	87	%
Operating temperature	-10	-	+55	°C
Storage temperature	-40	-	+85	°C
Relative humidity (non condensing)	-	-	93	%
IP rating		54		-
Contact Voltage - Fire & Fault relays (VFCO)	0.1	-	36	VDC
Contact Current - Fire & Fault relays (VFCO)	0.1	-	100	mA
Cable length - System Controller to Detector (2 core)	-	-	100	m
Cable gauge	24	-	14	AWG
	0.5	-	1.6	mm
Housing flammability rating	UL94 V0			
CPR Reference	0832-CPR-F0390			
UL File	S3417			

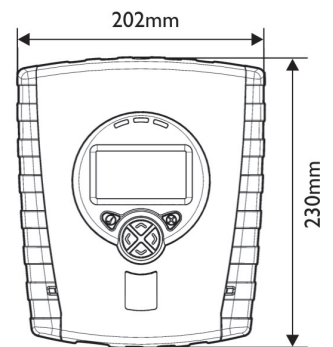
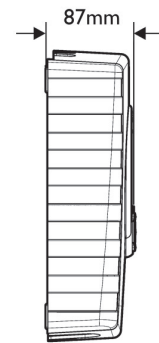
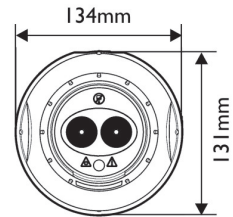
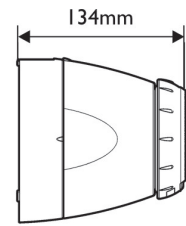

Dimensions and Weight

	Width mm	Height mm	Depth mm	Weight kg
System Controller, including base:	202	230	87	1.0
Detector, including 'easy fit' base: 1	134	131	134	0.5
Reflector:	100	100	10	0.1

All figures are quoted for 25°C

* 4 Reflectors required for > 50 m operation.

**To comply with EN54:12 set sensitivity levels between 25 & 30% with a maximum delay to fire of 20 seconds.

Installation Recommendations

Please refer to the User Guide (UG) for mounting, wiring and commissioning instructions. The installation of the Fireray® 5000 infra-red beam smoke detector should be undertaken in accordance with the recognised national, or international, standards and Codes of Practice (COP).

Specifications and wiring information are provided for information only and are believed to be accurate. FFE Ltd assumes no responsibility for their use. Data and design are subject to change without notice. Installation and wiring instructions are shipped with the products and should always be used for actual installation. For more information, contact your Sales Representative.

Document Part No: 24-0231-04



FFE Limited
9 Hunting Gate, Hitchin
Hertfordshire, SG4 0TJ UK

t +44 (0) 1462 444 740

e sales@ffeuk.com

w www.ffeuk.com

www.ffeuk.com